

PER L'ESECUZIONE DI FORI DI MEDIE E GRANDI DIMENSIONI NEL MURO.

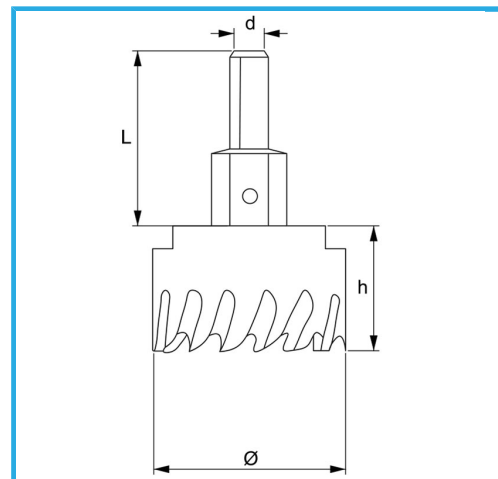

€20,50



Ø	25 mm
d	10 mm
Filetto	M12 x 1.25
Z	3
L	46 mm
Punta	Ø6 x 69 mm
Peso lordo	0,13 kg
Codice EAN	8012667352592



Append.

HSS

HM