

FOR DRILLING MEDIUM AND LARGE HOLES IN THE WALL.

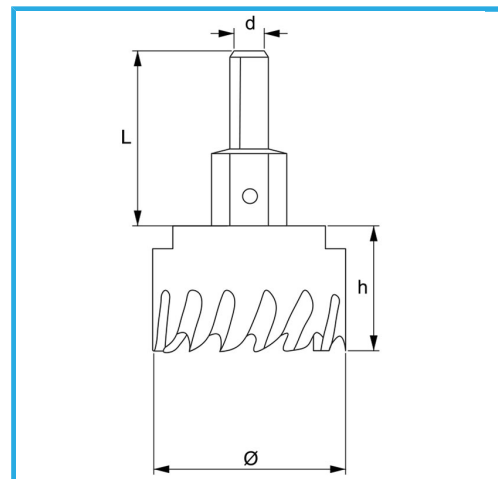

<b>Ø</b>	30 mm
<b>d</b>	10 mm
<b>Thread</b>	M12 x 1.25
<b>Z</b>	4
<b>L</b>	46 mm
<b>Boring bit</b>	Ø6 x 69 mm
<b>Gross weight</b>	0,15 kg
<b>EAN Code</b>	8012667352615



Hangable

**HSS**

**HM**

-