

FOR DRILLING MEDIUM AND LARGE HOLES IN THE WALL.

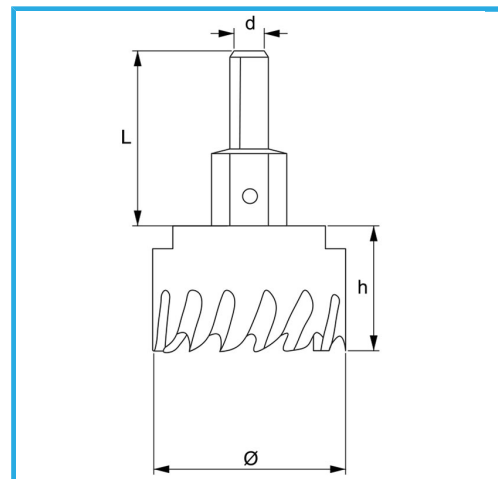

Ø	65 mm
d	12 mm
Thread	M16 x 1.5
Z	7
L	46 mm
Boring bit	Ø8 x 69 mm
Gross weight	0,41 kg
Packaging dimensions	70x70x130 h mm
EAN Code	8012667352691



Hangable

HSS

HM