

PER L'ESECUZIONE DI FORI DI MEDIE E GRANDI DIMENSIONI NEL MURO.

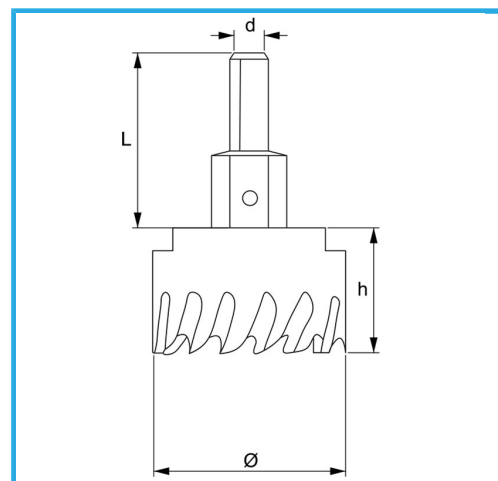

€43,10



Ø	65 mm
d	12 mm
Filetto	M16 x 1.5
Z	7
L	46 mm
Punta	Ø8 x 69 mm
Peso lordo	0,41 kg
Codice EAN	8012667352691



Append.

HSS

HM