

ZUM BOHREN MITTLERER UND GROßER LÖCHER IN DIE WAND.

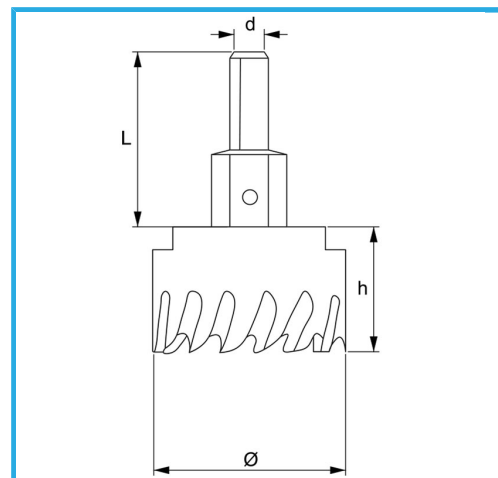

Ø	80 mm
d	12 mm
Gewinde	M16 x 1.5
Z	8
L	46 mm
Bohrer	Ø8 x 69 mm
Bruttogewicht	0,53 kg
EAN-Code	8012667352714



Aufhängbar

HSS

HM

-