

PER L'ESECUZIONE DI FORI DI MEDIE E GRANDI DIMENSIONI NEL MURO.

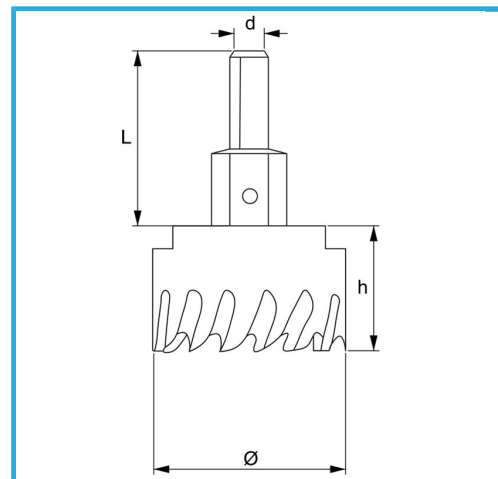

€61,40



Ø	80 mm
d	12 mm
Filetto	M16 x 1.5
Z	8
L	46 mm
Punta	Ø8 x 69 mm
Peso lordo	0,53 kg
Codice EAN	8012667352714



Append.

HSS

HM

-