

ART. P076/050
CORONAS CON DIENTES DE METAL DURO PARA
CONSTRUCCION



PARA TALADRAR AGUJEROS MEDIANOS Y GRANDES EN LA PARED.



€32,30

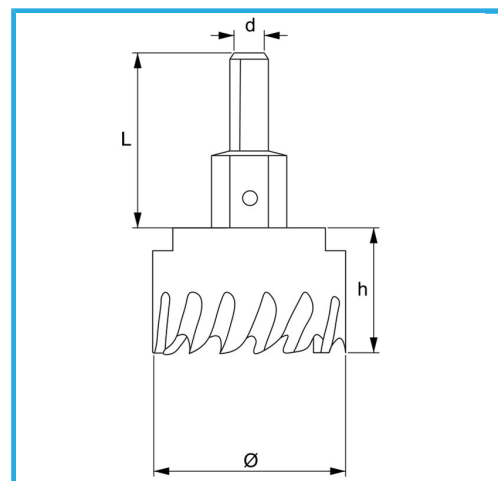

Ø	50 mm
d	10 mm
Rosca	M12 x 1.25
Z	6
L	46 mm
Broca	Ø6 x 69 mm
Peso bruto	0,27 kg
Codigo de barras	8012667352660



Colgante

HSS

HM