

PER L'ESECUZIONE DI FORI DI MEDIE E GRANDI DIMENSIONI NEL MURO.

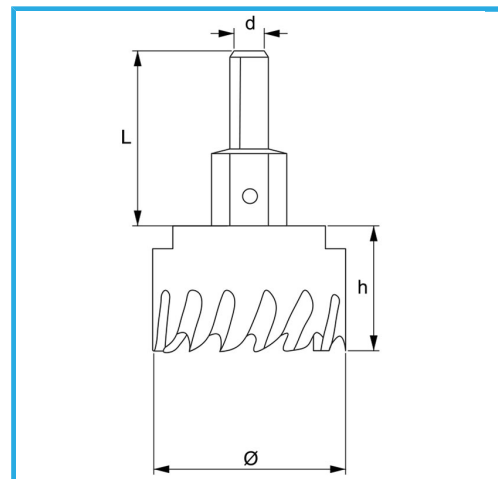

€32,30



Ø	50 mm
d	10 mm
Filetto	M12 x 1.25
Z	6
L	46 mm
Punta	Ø6 x 69 mm
Peso lordo	0,27 kg
Codice EAN	8012667352660



Append.

HSS

HM