

€41,50

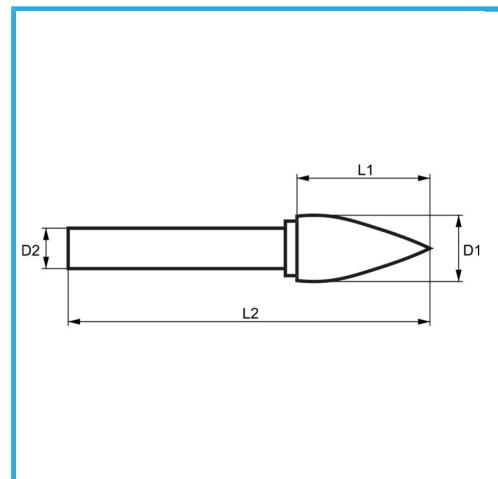

D1	ø16 mm
L1	25 mm
D2	6 mm
L2	70 mm
Peso lordo	0,07 kg
Codice EAN	8012667357580

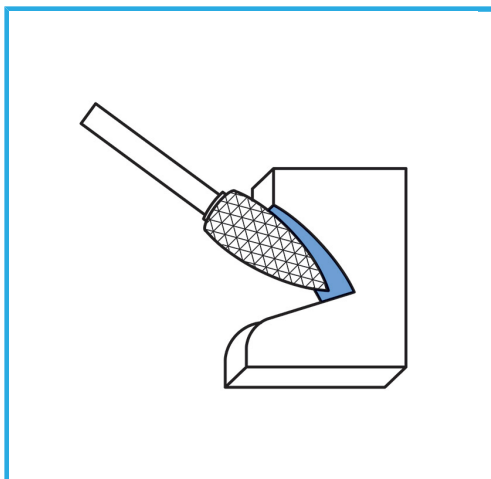

Scatola



HM