

€4,67

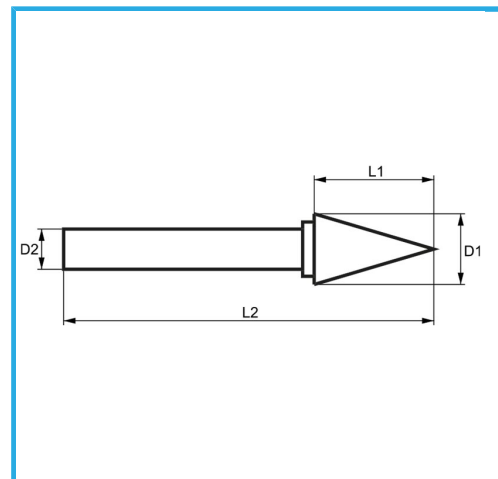

D1	ø3 mm
L1	11 mm
D2	3 mm
L2	38 mm
Peso lordo	0,01 kg
Codice EAN	8012667357825

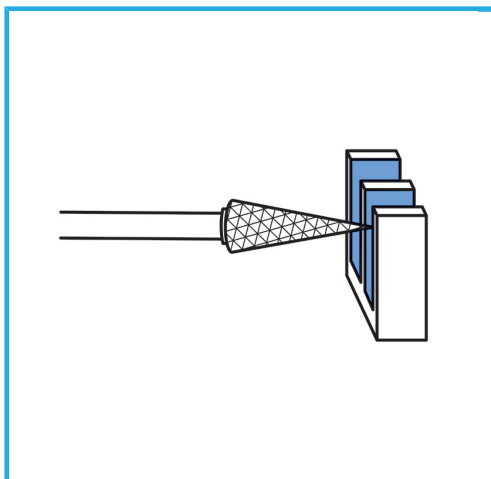

Scatola



-