

€18,20

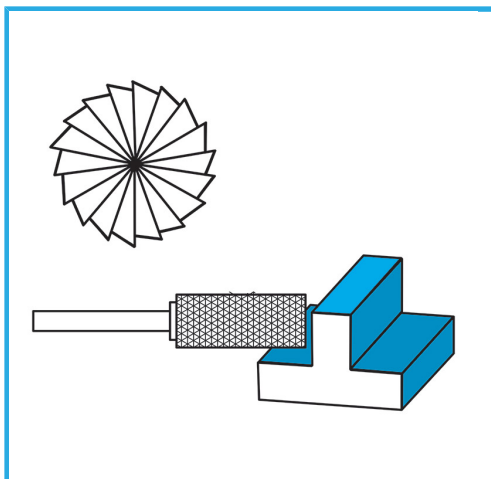

D1	ø10 mm
L1	20 mm
D2	6 mm
L2	65 mm
Peso lordo	0,04 kg
Dimensioni imballo	95x20x20 h mm
Codice EAN	8012667356606



Scatola



HM