

€10,40

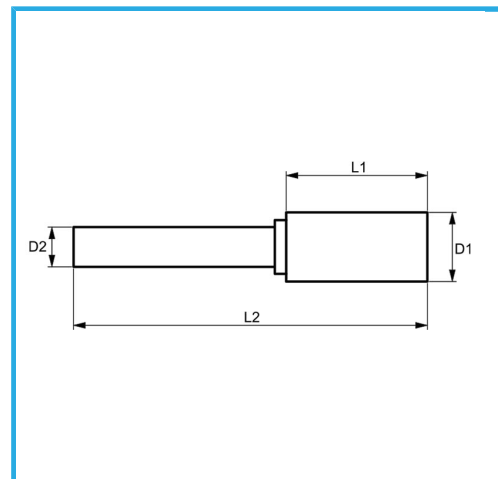

D1	ø4 mm
L1	13 mm
D2	6 mm
L2	58 mm
Peso lordo	0,02 kg
Dimensioni imballo	17 x 95 x 17 h mm
Codice EAN	8012667356576

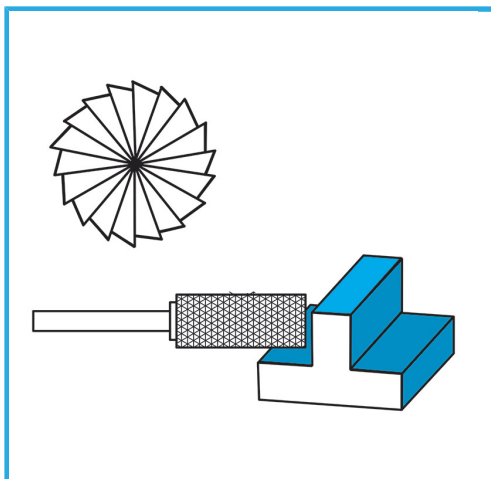

Scatola



HM

-