

€60,30

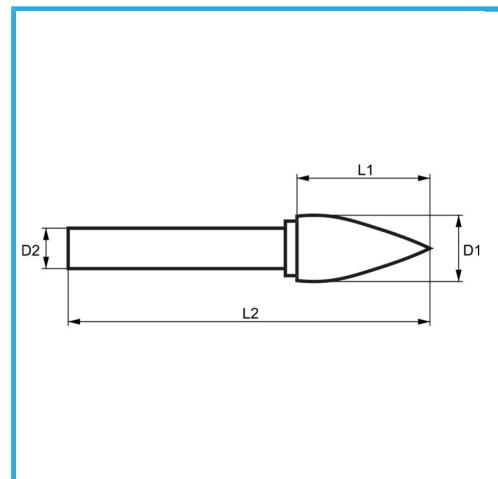

D1	ø19 mm
L1	25 mm
D2	6 mm
L2	70 mm
Peso lordo	0,09 kg
Codice EAN	8012667357597

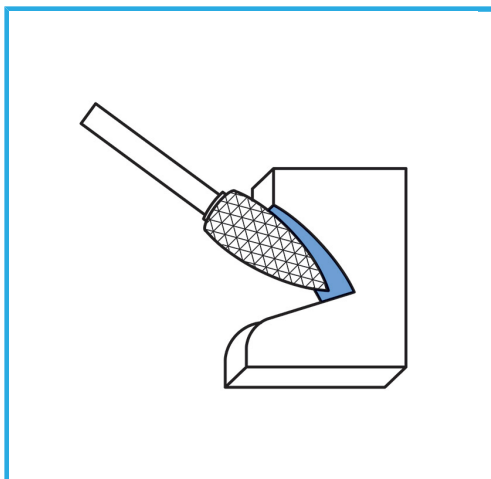

Scatola



HM