

€18,20

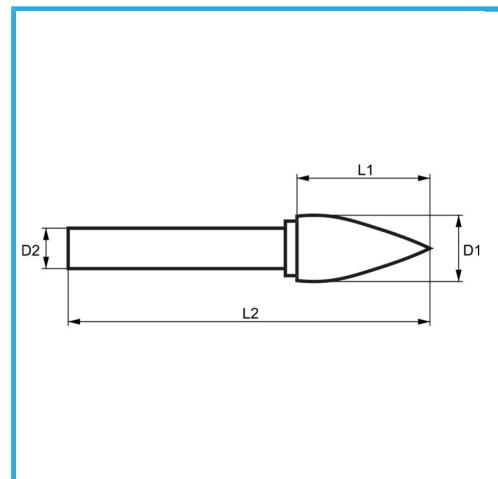

D1	ø10 mm
L1	20 mm
D2	6 mm
L2	65 mm
Peso lordo	0,02 kg
Dimensioni imballo	95x15x15 h mm
Codice EAN	8012667357566

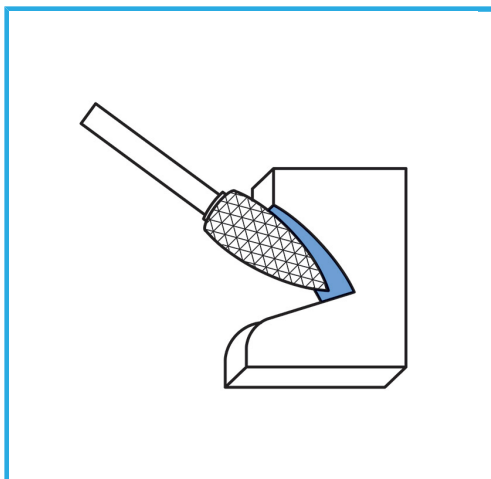

Scatola



HM