

€16,10

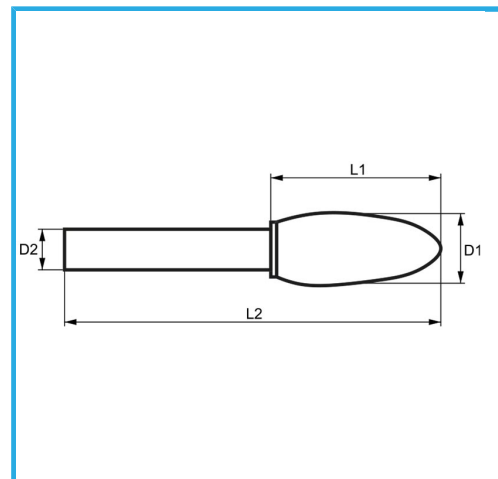

D1	ø10 mm
D2	25 mm
L1	6 mm
L2	70 mm
Peso lordo	0,03 kg
Codice EAN	8012667357672

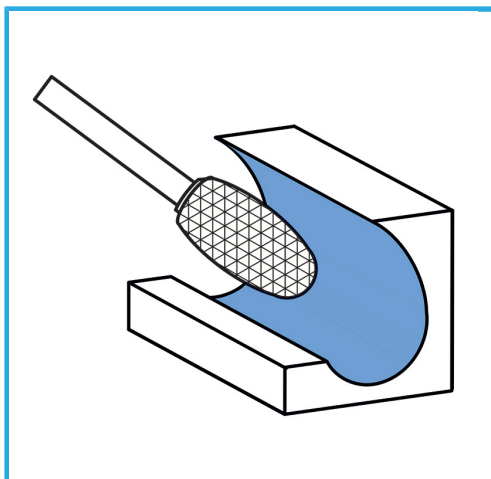

Scatola



-