

€9,90

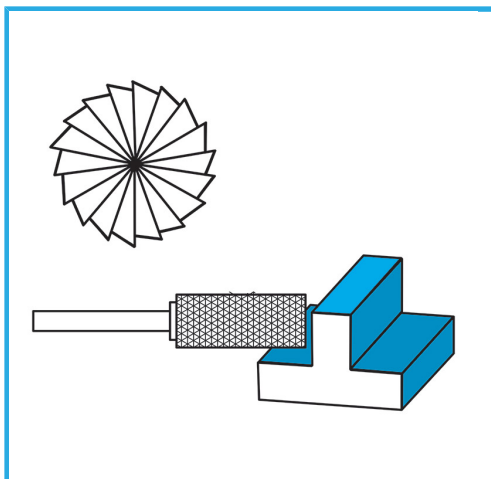

| | |
|------------|---------------|
| D1 | ø4 mm |
| L1 | 13 mm |
| D2 | 3 mm |
| L2 | 41 mm |
| Peso lordo | 0,01 kg |
| Codice EAN | 8012667356569 |



Scatola



-