

€14,60

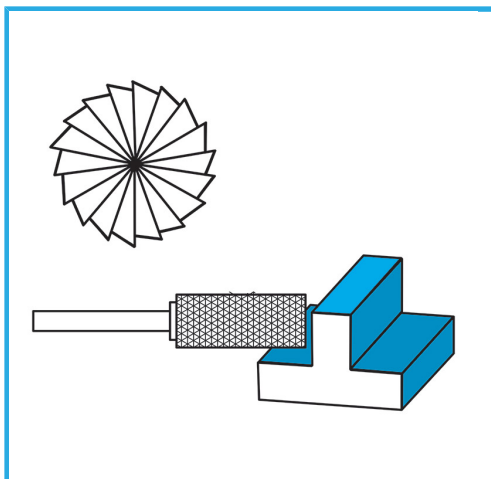

D1	ø8 mm
L1	20 mm
D2	6 mm
L2	65 mm
Peso lordo	0,03 kg
Codice EAN	8012667356590



Scatola



-