

€21,30

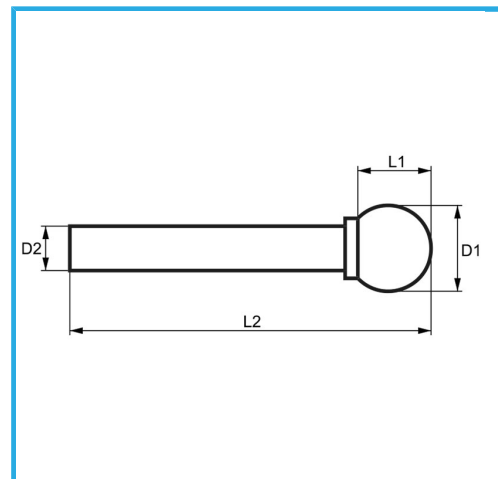

D1	ø12 mm
L1	10.8 mm
D2	6 mm
L2	56 mm
Dimensioni imballo	17 x 94 x 17 h mm
Peso lordo	0,03 kg
Codice EAN	8012667357191

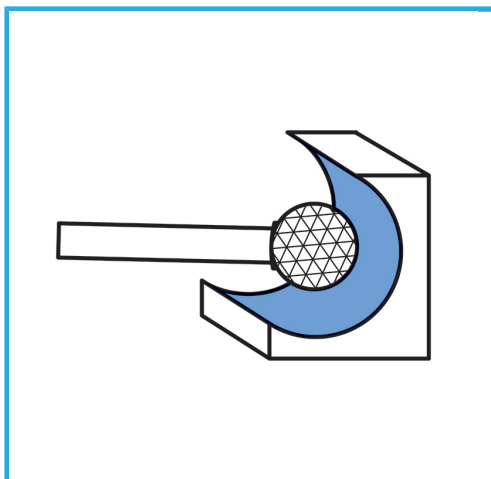

Scatola



HM