

€60,30

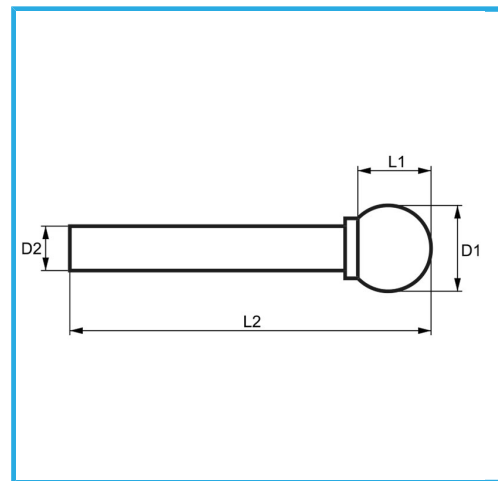

D1	ø19 mm
L1	17.4 mm
D2	6 mm
L2	64 mm
Dimensioni imballo	23 x 98 x 23 h mm
Peso lordo	0,07 kg
Codice EAN	8012667357214

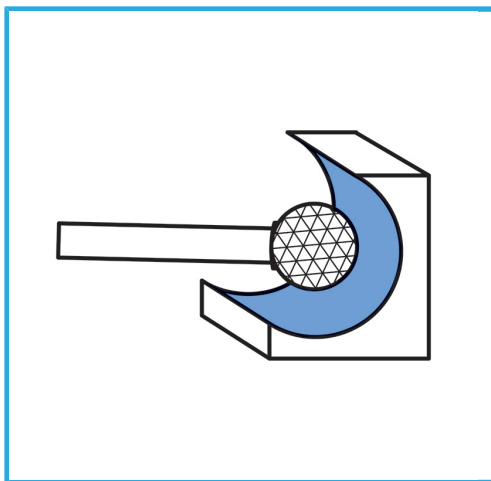

Scatola



HM