

€13,00

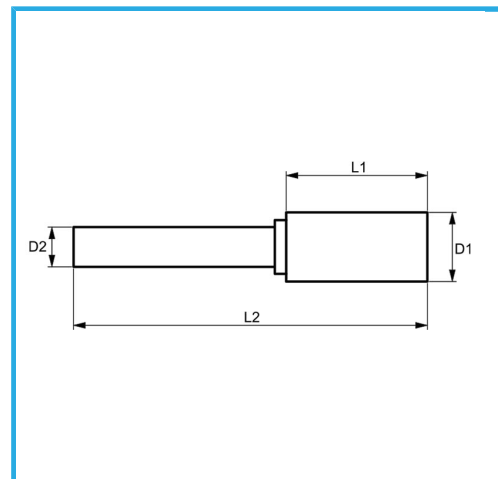

D1	ø6 mm
L1	16 mm
D2	6 mm
L2	61 mm
Peso lordo	0,02 kg
Dimensioni imballo	17 x 95 x 17 h mm
Codice EAN	8012667356583

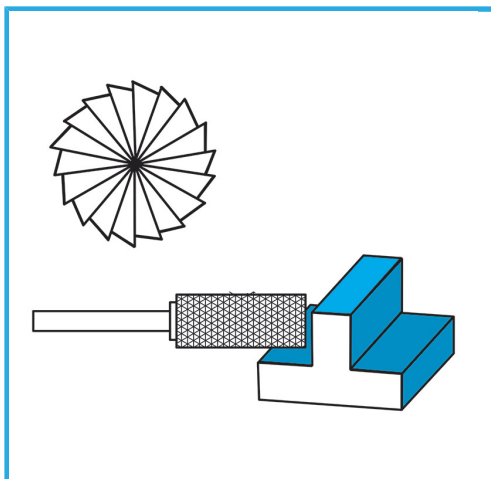

Scatola



HM

-