

€18,20

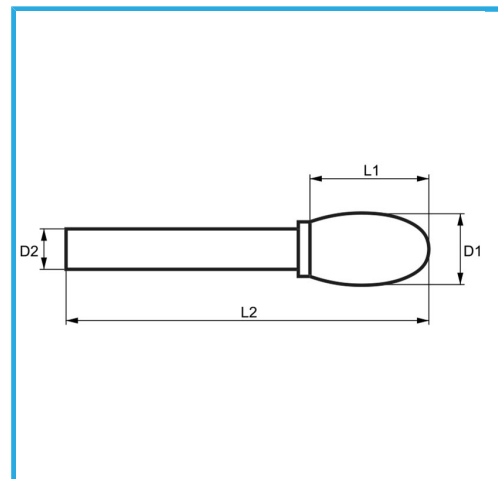

D1	ø10 mm
L1	16 mm
D2	6 mm
L2	61 mm
Dimensioni imballo	95 x 20 x 20 h mm
Peso lordo	0,03 kg
Codice EAN	8012667357306

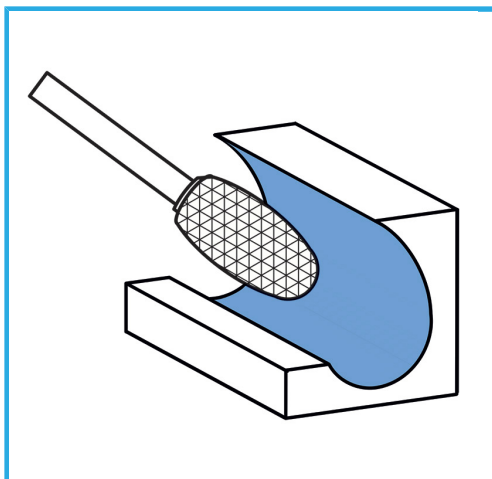

Scatola



-