

€6,10

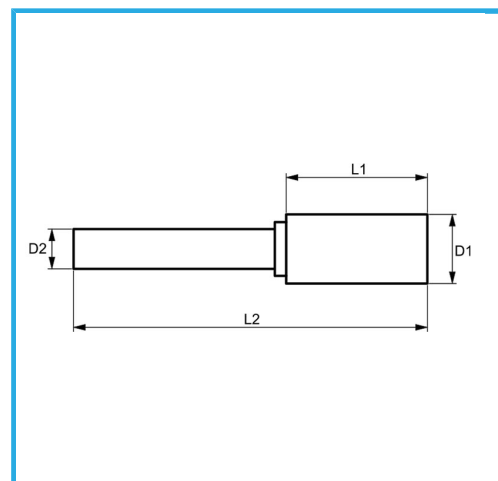

D1	ø2 mm
L1	10 mm
D2	3 mm
L2	65 mm
Peso lordo	0,01 kg
Codice EAN	8012667356750

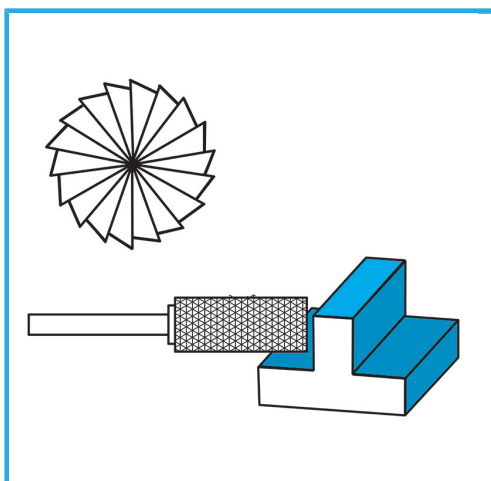

Scatola



-