

€13,00

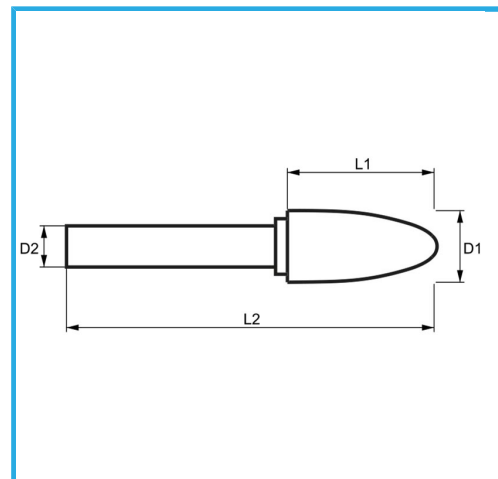

D1	ø6 mm
D2	18 mm
L1	6 mm
L2	63 mm
Peso lordo	0,02 kg
Codice EAN	8012667357429

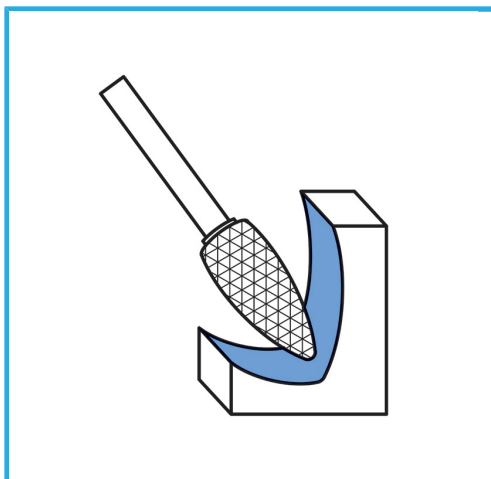

Scatola



-