

€18,20

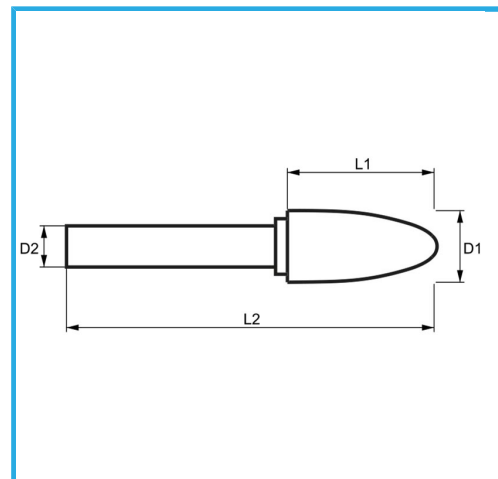

D1	ø10 mm
D2	20 mm
L1	6 mm
L2	65 mm
Peso lordo	0,03 kg
Codice EAN	8012667357443

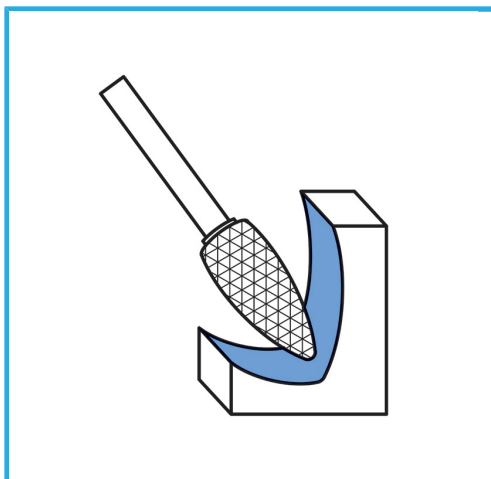

Scatola



-