

€41,50

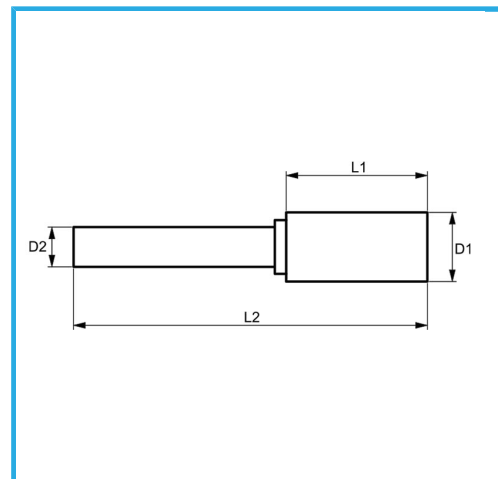

D1	ø16 mm
L1	25 mm
D2	6 mm
L2	70 mm
Peso lordo	0,09 kg
Dimensioni imballo	24 x 97 x 24 h mm
Codice EAN	8012667356620

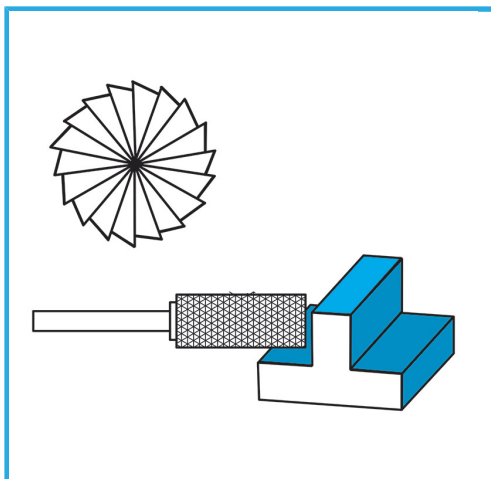

Scatola



HM

-