

SPEZIELL FÜR REPARATUREN ODER VERSTÄRKUNG VON
ZÜNDKERZENSITZEN.

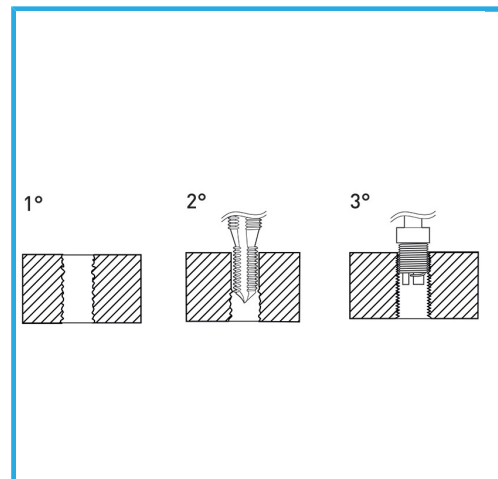
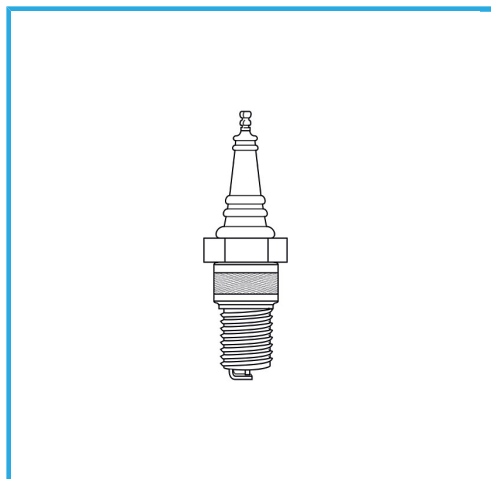

Maß

M 10 x 1.5

Montagewerkzeug

E011/U13 g

Gewindebohrer STI

E011/M100X150M

Gewindeeinsätze

10

EAN-Code

8012667367930

Bruttogewicht

-



Aufhängbar

HSS

-



INOX

-