

SPECIFICO PER RIPARAZIONI O RINFORZI SEDI CANDELE.

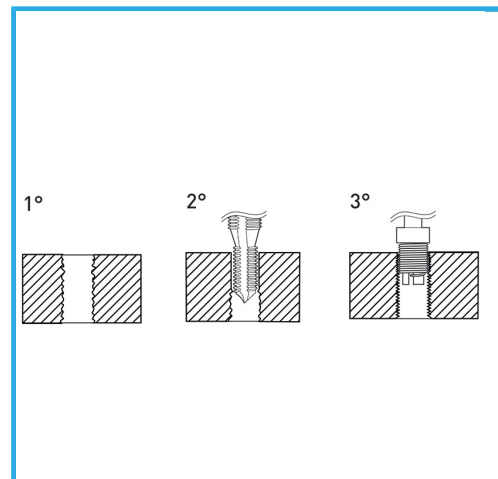

€46,30

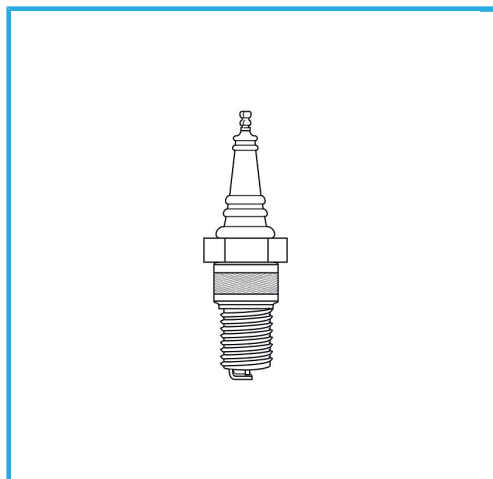

Misura	M 10 x 1.5
Utensile montaggio	E011/U13
Maschi STI	E011/M100X150M
Inserti filettati	10
Codice EAN	8012667367930
Peso lordo	-



Append.

HSS

-



INOX

-