

GEEIGNET ZUR GEWINDEREGENERATION ODER UM SEHR WIDERSTANDSFÄHIGES GEWINDESCHNEIDEN IN WEICHE MATERIALIEN ZU ERHALTEN.

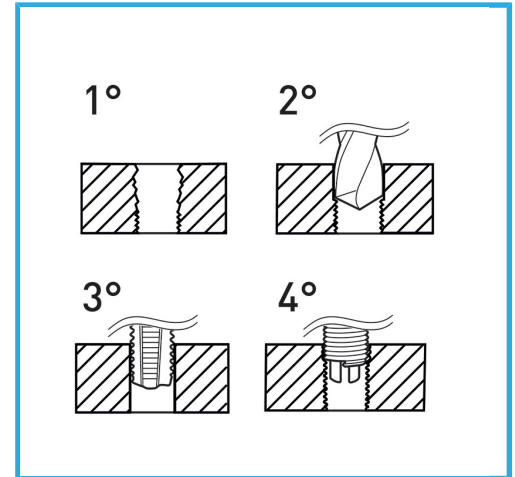

Gewinde	5/8" x 14
Bohrer	-
Gewindebohrer STI	E011/BSF5/8M
Montagewerkzeug	E011/U18 g
Brechwerkzeug	- g
Gewindeeinsätze	E010/BSF5/8E15
Anzahl der Einsätze	10
Bruttogewicht	0,68 kg
EAN-Code	8012667369057



Aufhängbar

HSS



INOX