

SUITABLE FOR THREAD REGENERATION OR TO OBTAIN VERY RESISTANT TAPPING IN SOFT MATERIALS.

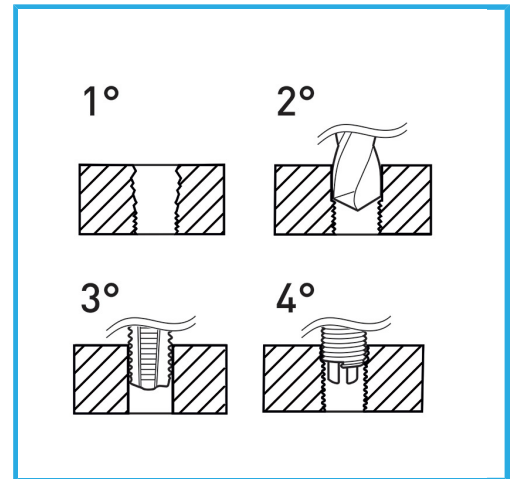

Dimensions	M 12 x 1.5
Boring bit	Ø 12.4 mm
STI Taps	E011/M120X150M
Inserting tool	E011/U15
Tang break tool	E011/A15
Inserts quantity	10
Gross weight	0,67 kg
EAN Code	8012667364779



Hangable

HSS



INOX