

SUITABLE FOR THREAD REGENERATION OR TO OBTAIN VERY RESISTANT TAPPING IN SOFT MATERIALS.

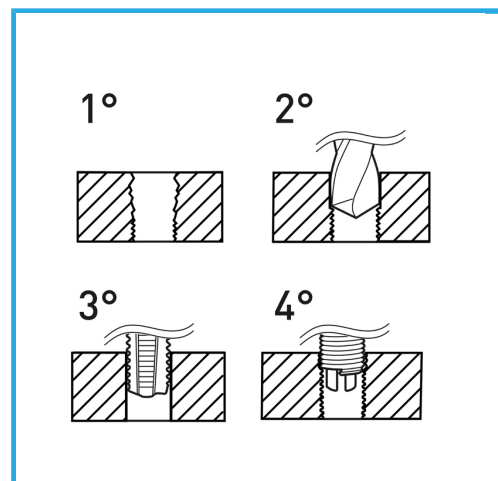

<b>Thread</b>	3/8" x 16
<b>Drills</b>	Ø 9.9 mm
<b>STI Taps</b>	E011/UNC3/8M
<b>Inserting tool</b>	E011/U06
<b>Tang break tool</b>	E011/A06
<b>Wire-thread inserts</b>	E010/UNC3/8E15
<b>Inserts quantity</b>	20
<b>Packaging dimensions</b>	170x130x40 h mm
<b>Gross weight</b>	0,52 kg
<b>EAN Code</b>	8012667365561



Hangable

HSS



INOX