

SUITABLE FOR THREAD REGENERATION OR TO OBTAIN VERY RESISTANT TAPPING IN SOFT MATERIALS.

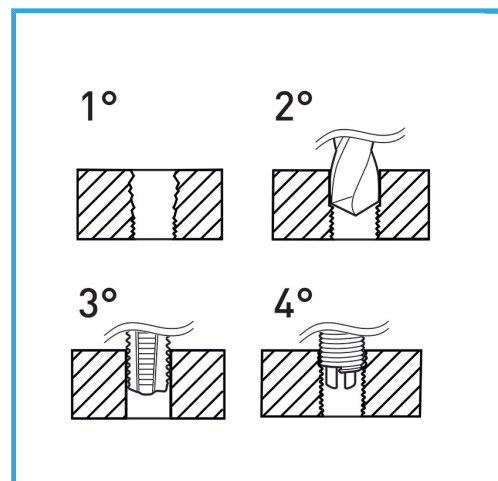

Thread	1/4" x 26
Boring bit	Ø 6.6 mm
STI Taps	E011/BSF1/4M
Inserting tool	E011/U09
Tang break tool	E011/A09
Wire-thread inserts	E010/BSF1/4E15
Inserts quantity	20
Gross weight	0,42 kg
EAN Code	8012667365059



Hangable

HSS



INOX