

INDICADO PARA LA REGENERACIÓN DE ROSCAS O PARA OBTENER ROSCADOS MUY RESISTENTES EN MATERIALES BLANDOS.

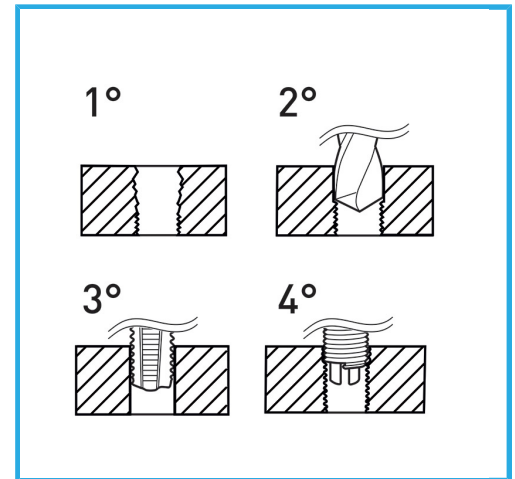

€32,70



Rosca	1/4" x 26
Broca	Ø 6.6 mm
Machos STI	E011/BSF1/4M
Utensilio para insertar	E011/U09
Herr. rompe arrastre	E011/A09
Insertos roscados	E010/BSF1/4E15
Cantidad de insertos	20
Peso bruto	0,42 kg
Codigo de barras	8012667365059



Colgante

HSS



INOX