

ADATTI PER LA RIGENERAZIONE DELLE FILETTATURE O PER OTTENERE DELLE MASCHIATURE MOLTO RESISTENTI IN MATERIALI TENERI.

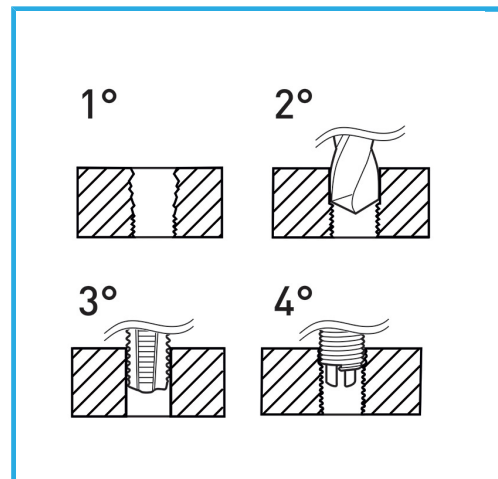

€32,70



Filetto	1/4" x 26
Punta	Ø 6.6 mm
Maschi STI	E011/BSF1/4M
Utensile montaggio	E011/U09
Attrezzo rottura	E011/A09
Inserti filettati	E010/BSF1/4E15
Quantità inserti	20
Peso lordo	0,42 kg
Codice EAN	8012667365059



Append.

HSS



INOX