

SUITABLE FOR THREAD REGENERATION OR TO OBTAIN VERY RESISTANT TAPPING IN SOFT MATERIALS.

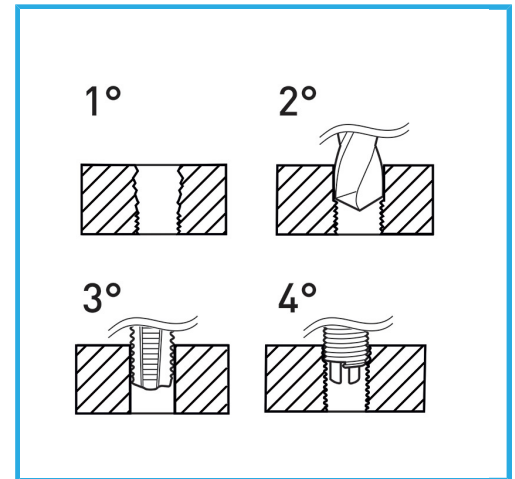

<b>Dimensions</b>	M 24 x 2.0
<b>Boring bit</b>	-
<b>STI Taps</b>	E011/M240X200M
<b>Inserting tool</b>	E011/U23
<b>Tang break tool</b>	-
<b>Inserts quantity</b>	5
<b>Gross weight</b>	1,06 kg
<b>EAN Code</b>	8012667366674



Hangable

HSS



INOX