

GEEIGNET ZUR GEWINDEREGENERATION ODER UM SEHR WIDERSTANDSFÄHIGES GEWINDESCHNEIDEN IN WEICHE MATERIALIEN ZU ERHALTEN.

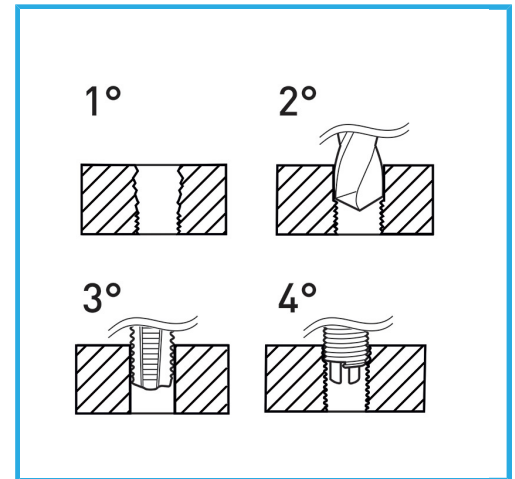

Abmessungen	M 20 x 2.0
Bohrer	-
Gewindebohrer STI	E011/M200X200M
Montagewerkzeug	E011/U21 g
Brechwerkzeug	- g
Anzahl der Einsätze	5
Bruttogewicht	0,81 kg
EAN-Code	8012667366438



Aufhängbar

HSS



INOX