

SUITABLE FOR THREAD REGENERATION OR TO OBTAIN VERY RESISTANT TAPPING IN SOFT MATERIALS.

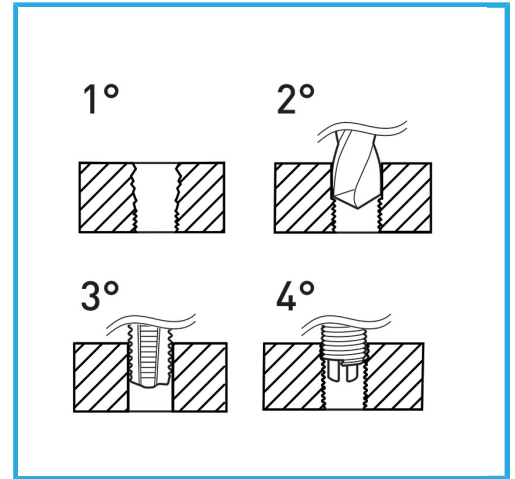

Dimensions	M 24 x 1.5
Boring bit	-
STI Taps	E011/M240X150M
Inserting tool	E011/U23
Tang break tool	-
Inserts quantity	5
Gross weight	1,06 kg
EAN Code	8012667364168



Hangable

HSS



INOX