

SUITABLE FOR THREAD REGENERATION OR TO OBTAIN VERY RESISTANT TAPPING IN SOFT MATERIALS.

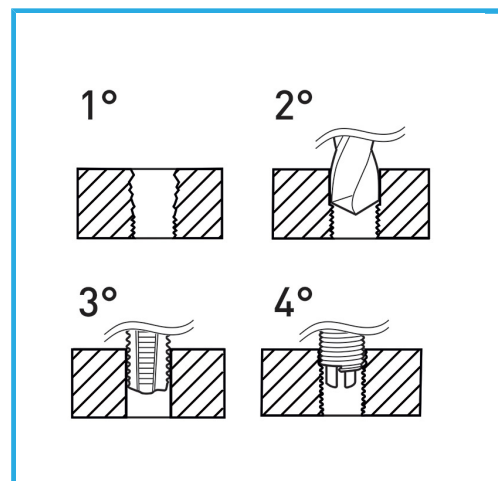

<b>Dimensions</b>	M 7 x 1.0
<b>Boring bit</b>	Ø 7.3 mm
<b>STI Taps</b>	E011/M070X100M
<b>Inserting tool</b>	E011/U10
<b>Tang break tool</b>	E011/A11
<b>Inserts quantity</b>	20
<b>Gross weight</b>	0,42 kg
<b>EAN Code</b>	8012667363802



Hangable

HSS



INOX