

INDICADO PARA LA REGENERACIÓN DE ROSCAS O PARA OBTENER ROSCADOS MUY RESISTENTES EN MATERIALES BLANDOS.

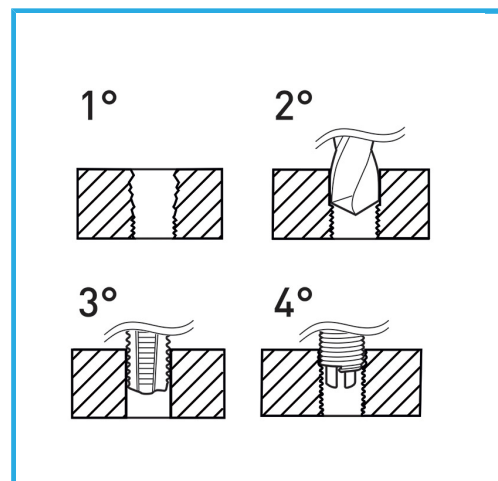

€39,40



Rosca	5/16" x 18
Broca	Ø 8.3 mm
Machos STI	E011/BSW5/16M
Utensilio para insertar	E011/U10
Herr. rompe arrastre	E011/A11
Insertos roscados	E010/BSW5/16E15
Cantidad de insertos	20
Peso bruto	0,46 kg
Codigo de barras	8012667365332



Colgante

HSS



INOX