

SUITABLE FOR THREAD REGENERATION OR TO OBTAIN VERY RESISTANT TAPPING IN SOFT MATERIALS.

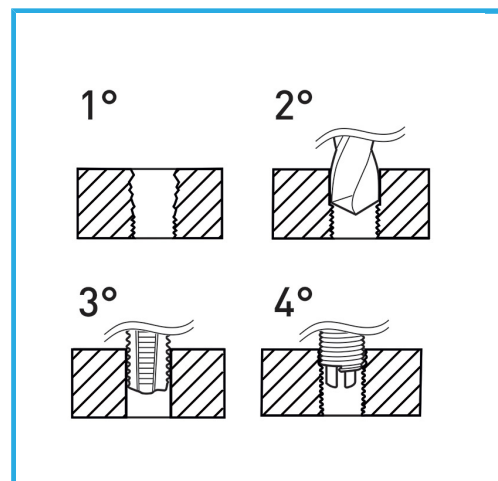

Dimensions	M 6 x 1.0
Boring bit	Ø 6.3 mm
STI Taps	E011/M060X100M
Inserting tool	E011/U09
Tang break tool	E011/A09
Inserts quantity	20
Gross weight	0,41 kg
EAN Code	8012667367411



Hangable

HSS



INOX