

ADATTI PER LA RIGENERAZIONE DELLE FILETTATURE O PER OTTENERE DELLE MASCHIATURE MOLTO RESISTENTI IN MATERIALI TENERI.

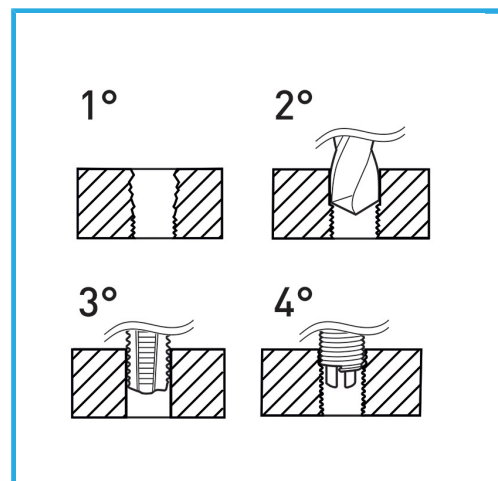

€30,20



Dimensioni	M 6 x 1.0
Punta	Ø 6.3 mm
Maschi STI	E011/M060X100M
Utensile montaggio	E011/U09
Attrezzo rottura	E011/A09
Quantità inserti	20
Peso lordo	0,41 kg
Codice EAN	8012667367411



Append.

HSS -



INOX -