

GEEIGNET ZUR GEWINDEREGENERATION ODER UM SEHR WIDERSTANDSFÄHIGES GEWINDESCHNEIDEN IN WEICHE MATERIALIEN ZU ERHALTEN.

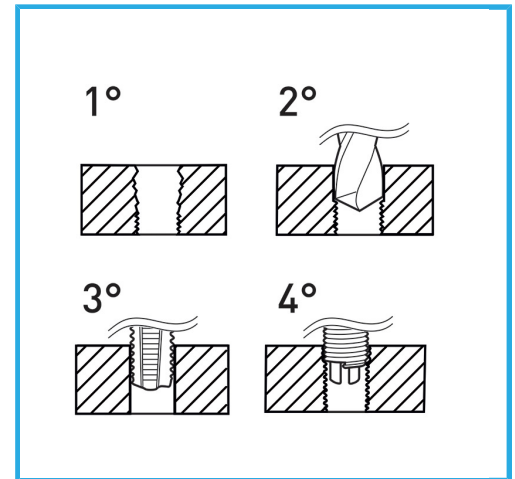

Gewinde	3/16" x 24
Bohrer	Ø 5.0 mm
Gewindebohrer STI	E011/BSW3/16M
Montagewerkzeug	E011/U08 g
Brechwerkzeug	E011/A8 g
Gewindeeinsätze	E010/BSW3/16E15
Anzahl der Einsätze	20
Bruttogewicht	0,38 kg
EAN-Code	8012667368265



Aufhängbar

HSS



INOX