

SUITABLE FOR THREAD REGENERATION OR TO OBTAIN VERY RESISTANT TAPPING IN SOFT MATERIALS.

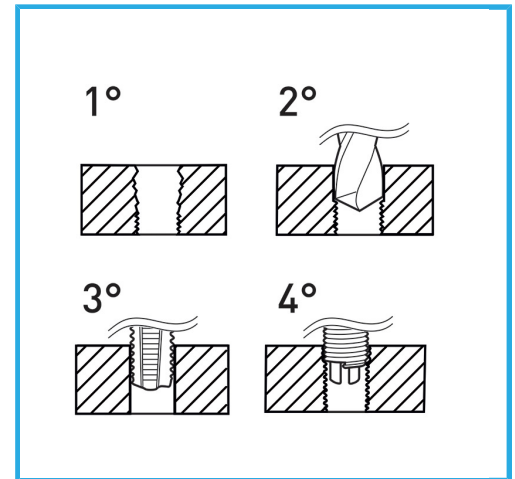

Thread	3/16" x 24
Boring bit	Ø 5.0 mm
STI Taps	E011/BSW3/16M
Inserting tool	E011/U08
Tang break tool	E011/A8
Wire-thread inserts	E010/BSW3/16E15
Inserts quantity	20
Gross weight	0,38 kg
EAN Code	8012667368265



Hangable

HSS



INOX