

INDICADO PARA LA REGENERACIÓN DE ROSCAS O PARA OBTENER ROSCADOS MUY RESISTENTES EN MATERIALES BLANDOS.

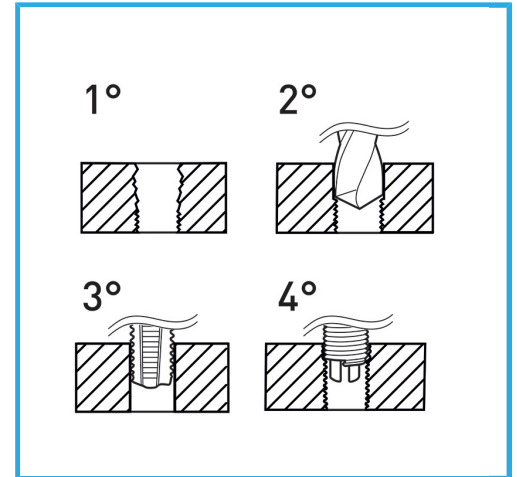

€35,90



Rosca	3/16" x 24
Broca	Ø 5.0 mm
Machos STI	E011/BSW3/16M
Utensilio para insertar	E011/U08
Herr. rompe arrastre	E011/A8
Insertos roscados	E010/BSW3/16E15
Cantidad de insertos	20
Peso bruto	0,38 kg
Codigo de barras	8012667368265



Colgante

HSS



INOX