

INDICADO PARA LA REGENERACIÓN DE ROSCAS O PARA OBTENER ROSCADOS MUY RESISTENTES EN MATERIALES BLANDOS.

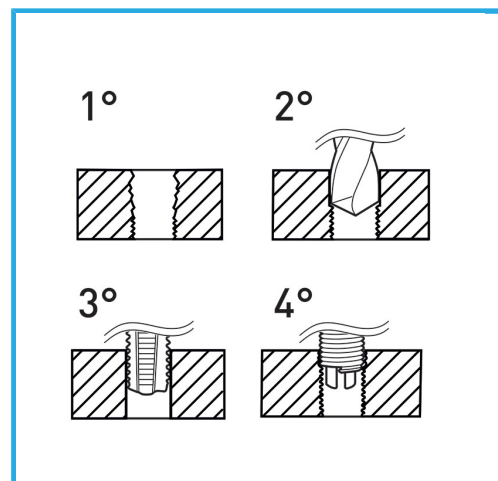

€50,80



Rosca	1/2" x 16
Broca	Ø 13.0 mm
Machos STI	E011/BSF1/2M
Utensilio para insertar	E011/U15
Herr. rompe arrastre	E011/A15
Insertos roscados	E010/BSF1/2E15
Cantidad de insertos	10
Peso bruto	0,66 kg
Codigo de barras	8012667363543



Colgante

HSS



INOX