

ADATTI PER LA RIGENERAZIONE DELLE FILETTATURE O PER OTTENERE DELLE MASCHIATURE MOLTO RESISTENTI IN MATERIALI TENERI.

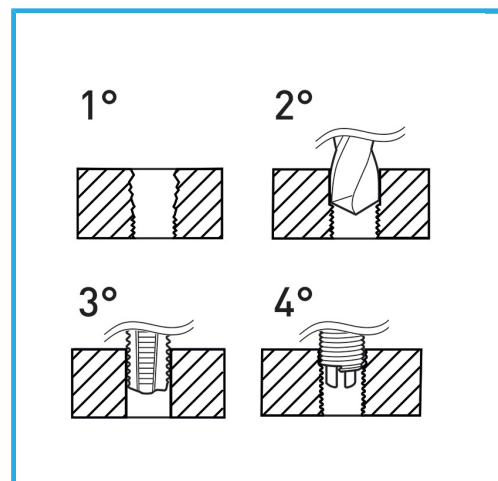

€89,30



Dimensioni	M 22 x 2.0
Punta	-
Maschi STI	E011/M220X200M
Utensile montaggio	E011/U22
Attrezzo rottura	-
Quantità inserti	5
Peso lordo	0,92 kg
Codice EAN	8012667369118



Append.

HSS



INOX