

GEEIGNET ZUR GEWINDEREGENERATION ODER UM SEHR WIDERSTANDSFÄHIGES GEWINDESCHNEIDEN IN WEICHE MATERIALIEN ZU ERHALTEN.

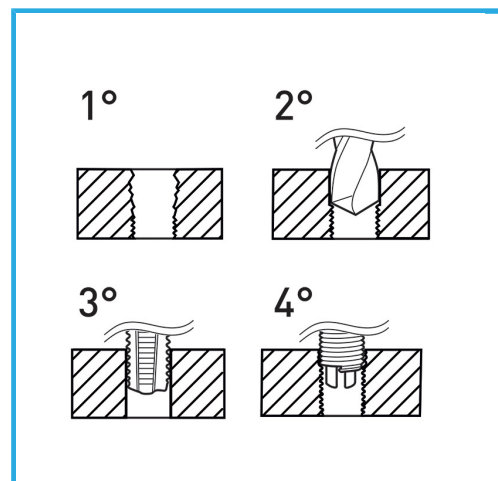

Gewinde	1/4" x 20
Bohrer	Ø 6.7 mm
Gewindebohrer STI	E011/BSW1/4M
Montagewerkzeug	E011/U09 g
Brechwerkzeug	E011/A9 g
Gewindeeinsätze	E010/BSW1/4E15
Anzahl der Einsätze	20
Bruttogewicht	0,41 kg
EAN-Code	8012667365455



Aufhängbar

HSS



INOX