

SUITABLE FOR THREAD REGENERATION OR TO OBTAIN VERY RESISTANT TAPPING IN SOFT MATERIALS.

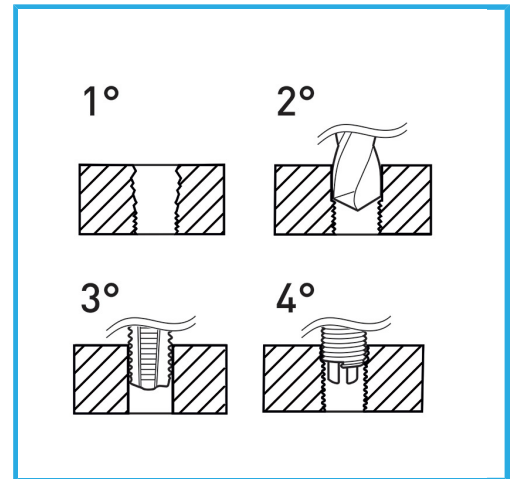

Dimensions	M 18 x 2.0
Boring bit	-
STI Taps	E011/M180X200M
Inserting tool	E011/U20
Tang break tool	-
Inserts quantity	5
Gross weight	0,73 kg
EAN Code	8012667365356



Hangable

HSS



INOX