

INDICADO PARA LA REGENERACIÓN DE ROSCAS O PARA OBTENER ROSCADOS MUY RESISTENTES EN MATERIALES BLANDOS.

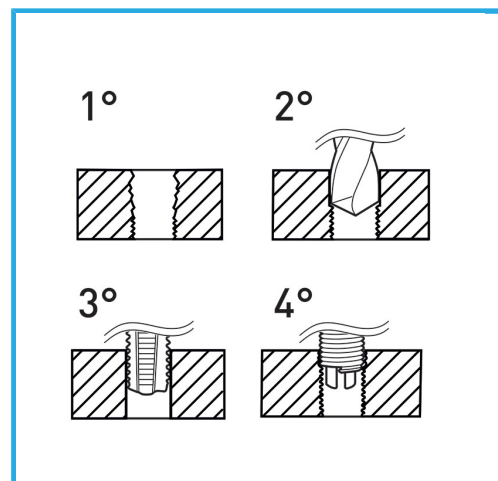

€41,90



Rosca	3/8" x 20
Broca	Ø 9.9 mm
Machos STI	E011/BSF3/8M
Utensilio para insertar	E011/U13
Herr. rompe arrastre	E011/A13
Insertos roscados	E010/BSF3/8E15
Cantidad de insertos	15
Peso bruto	0,52 kg
Codigo de barras	8012667367145



Colgante

HSS



INOX