

INDICADO PARA LA REGENERACIÓN DE ROSCAS O PARA OBTENER ROSCADOS MUY RESISTENTES EN MATERIALES BLANDOS.

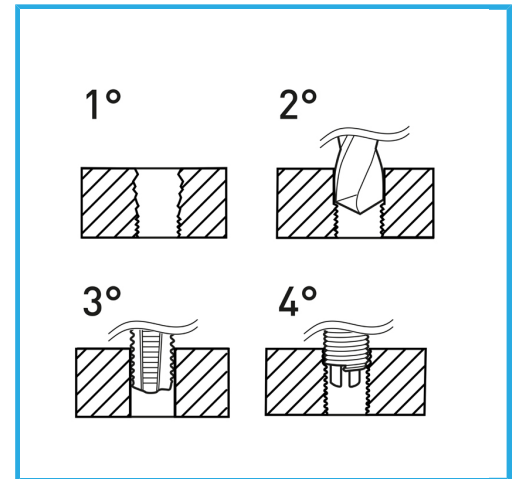

€31,70



Rosca	1/4" x 20
Brocas	Ø 6.7 mm
Machos STI	E011/UNC1/4M
Utensilio para insertar	E011/U09
Herr. rompe arrastre	E011/A09
Insertos roscados	E010/UNC1/4E15
Cantidad de insertos	20
Peso bruto	0,41 kg
Codigo de barras	8012667366070



Colgante

HSS



INOX