

ADATTI PER LA RIGENERAZIONE DELLE FILETTATURE O PER OTTENERE DELLE MASCHIATURE MOLTO RESISTENTI IN MATERIALI TENERI.

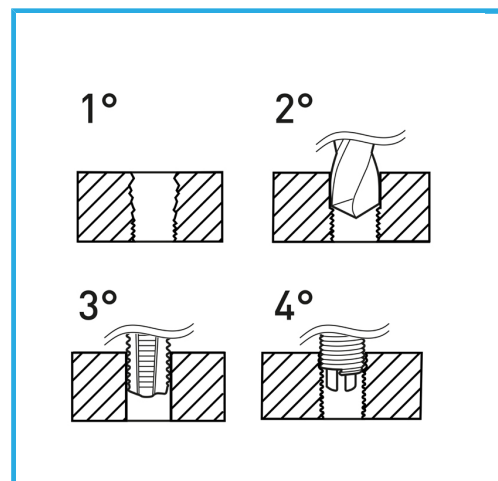

€31,70



Filetto	1/4" x 20
Punte	Ø 6.7 mm
Maschi STI	E011/UNC1/4M
Utensile montaggio	E011/U09
Attrezzo rottura	E011/A09
Inserti filettati	E010/UNC1/4E15
Quantità inserti	20
Dimensioni imballo	170x130x40 h mm
Peso lordo	0,41 kg
Codice EAN	8012667366070



Append.

HSS



INOX